



VHF-Transceiver

AR6201-(XXX)

Installation and Operation

Manual
Issue 2

DV 14300.03
October 2010

Becker Flugfunkwerk GmbH • Baden Airpark • 77836 Rheinmünster • Germany

Telephone +49 (0) 7229 / 305-0 • Fax +49 (0) 7229 / 305-217

<http://www.becker-avionics.com> • e-mail: info@becker-avionics.de

FIRST ISSUE AND CHANGES

Issue 1 May 2010
Issue 2 October 2010

LIST OF EFFECTIVE PAGES

Page No.:	Date:	Page No.:	Date:
Cover Page	10/2010		
1-I ... 1-II	10/2010		
1-1 ... 1-10	10/2010		
2-I ... 2-II	10/2010		
2-1 ... 2-26	10/2010		
3-I ... 3-II	10/2010		
3-1 ... 3-14	10/2010		

Table of contents

Section	1	GENERAL DESCRIPTION	Page
1.1		Introduction	1
1.2		Purpose of equipment	1
1.3		General Notes	1
1.4		Short Description	2
1.5		Variants survey	4
1.6		Technical data	4
1.6.1		Power supply data	4
1.6.2		General data	4
1.6.3		Dimensions & Weight	5
1.6.4		Receiver data	5
1.6.5		Transmitter data	5
1.6.6		Software	6
1.6.7		Approval	6
1.7		Environmental Qualification	7
1.8		Accessories	9



AR6201

Blank

Section 1 GENERAL

1.1 Introduction

This manual describes the VHF transceiver AR6201-(XXX). The manuals DV 14300.03 (“Installation and Operation”) and DV 14300.04 (“Maintenance and Repair”) contain the following sections.

Section		DV 14300.03	DV 14300.04
1	General	X	X
2	Installation	X	X
3	Operation	X	X
4	Theory of operation	N/A	X
5	Maintenance and Repair	N/A	X
6	Illustrated Parts List	N/A	X
7	Modification and Changes	N/A	X
8	Circuit Diagrams	N/A	X

1.2 Purpose of equipment

The VHF transceiver enables voice communication in the very high frequency band between 118.000 MHz to 136.9916 MHz (radio communication part of air-band) with a selectable channel spacing of 25 kHz or 8.33 kHz.

1.3 General Notes

The word “frequency” in this document is also used in the sense of “channel name” as defined in EUROCAE, ED-23B, chapter 1.3.2.

The word “memory channel” or “channel” used in this document means a memory place identified by a channel number. On that memory place a frequency may be stored for later use.

1.4 Short Description

The VHF transceiver is designed as a single block unit for usage in cockpit environment of general aviation aircrafts including helicopters under consideration of performed environmental qualification (refer chapter 1.7) and SW Level (refer chapter 1.6.6).

The VHF transceiver is a compact and lightweight single block unit. The dimensions correspond to the standard instrument diameter of 58 mm (2 1/4 inch). Mounting is by means of four screws (rear panel installation). All controls and indicators are located on the front panel. The equipment connectors and the antenna socket are located at the rear of the unit.

Frequency Indication

The frequency indication is done by means of a liquid crystal display (LCD). The required operating frequency is set with the rotary knob. The relation between the real operating frequency and the displayed frequency is according to standards (ED-23B, chapter 1.3.2). For overview refer table below.

Operating Frequency (MHz)	Channel Spacing (kHz)	Displayed Frequency in 8.33+25 kHz mixed Mode	Displayed Frequency in 25 kHz Mode
118.0000	25	118.000	118.00
118.0000	8.33	118.005	N/A
118.0083	8.33	118.010	N/A
118.0166	8.33	118.015	N/A
118.0250	25	118.025	118.02
etc.	etc.	etc.	etc.
136.9916	8.33	136.990	N/A

Audio outputs

The transceiver includes two audio outputs: Headphone and Speaker. The Headphone rated output power is 300 mW into 150 Ohm. The rated output power from the Speaker Output is 4 W into 4 Ohm.

Mike inputs

The VHF transceiver has an input for dynamic microphone (DYN_MIKE) and an input for standard microphone (STD_MIKE). Each input is able to operate with single microphone or with 2 microphones of the same type connected in parallel.

AF auxiliary input

The AF auxiliary input enables to connect an external audio source (NAV, music-player ...) to the transceiver. The external audio will be audible only when transceiver is in receive operation.

Sidetone

The sidetone is available on the headphone output during transmission. The sidetone volume is coupled with the Intercom Volume.

Squelch Operation

There are two kinds of squelch methods implemented, carrier squelch and noise squelch. The carrier squelch is based on received signal strength and adjustable in installation setup; the noise squelch is based on detected noise level and adjustable in pilot setup.

Memory channels

The VHF transceiver also contains a channel memory device for automatically/manually storage of 99 frequencies. The last 9 used (active) frequencies are always stored automatically. In addition a manual storage of up to 90 different frequencies is possible.

Intercom operation

Aircraft internal communication via connected headsets is possible due to the internal built in intercom. Intercom operation may be triggered automatically via VOX (adjustable) or externally via intercom switch. Setting of VOX-threshold and Intercom Volume is accessible by pilot in the intercom menu.

Scan Mode

In scan mode (also called dual watch function) the device is capable to monitor two frequencies (active & preset) at the same time.

Illumination

The illumination of LCD and push buttons can be controlled either internally from the front panel knob or externally via the dimming inputs. In case of external dimming the illumination curve (brightness to voltage relation) can be adjusted in the installation setup.

LOW BATT Indication

The VHF transceiver also contains a monitoring stage for the power supply voltage. If the supply voltage drops below the adjustable threshold, the display indicates the message "LOW BATT". The factory setting for that adjustable threshold is 10.5 V.

Emergency operation

In emergency operation (from 9.0 to 10.25 V) the performance of the device is degraded:

- For TX Mode: RF Rated power is $\geq 2 \text{ W @ } 50 \text{ Ohm}$, modulation depth is $\geq 50 \%$,
- For RX Mode: $(S+N)/N \geq 6 \text{ dB}$ for RF level -93 dBm , $m = 30\%$, 1 kHz sine
- Panel Backlight is switched off
- Speaker output is switched off.** Only the headphone output is still operating.

CAUTION:

For power supply voltages below 10 V the speaker output of the transceiver is automatically switched off, without dedicated notification of the user. !

Depending on settings of installation setup "LOW BATT" may be indicated if supply voltage drops below predefined threshold.

If this threshold is adjusted in range 10.2 ... 10.5V this "LOW BATT" warning may also indicate to the user, that he should connect his headset (because speaker may be switched off soon).

Built In Tests

After switch on, the unit performs a self test (PBIT). During PBIT the transceiver shows "WAIT" and the corresponding software versions of the control head and chassis module. During normal operation a continuous built in test (CBIT) verifies the correct operation of the unit in background. In case of problems a warning or failure message will be displayed.

Installation Setup

Configuration of the installation parameters like mike sensitivity, mike type selection, speaker enable/disable and further parameters is possible via Installation Setup.

Service Mode

Special factory configuration of the system is possible in Service Mode via a RS422 interface with a proprietary serial data communication protocol.

1.5 Variants survey

Part-Number:	Article Number	Panel Color	Display Color
AR6201-(000)	0610.321-910	black	green
AR6201-(002)	0614.203-910	black	blue / white

1.6 Technical data

1.6.1 Power supply data

Nominal supply voltage range	11.0 ... 30.3 V DC
Abnormal supply voltage range	10.25 V ... 32.2V DC
Emergency operation	9.0 V DC ... 10.25 V DC (degraded performance)
Power consumption	
Power off state	≤ 2.5 mA
Reception mode	≤ 140 mA @ 14 V DC, panel backlight off
Transmission mode	≤ 2 A @ 14 V DC, 70 % modulated, VSWR = 1:1 ≤ 4 A @ 14 V DC; 70 % modulated, VSWR = 3:1
DC-Fuse internal	5 A (resettable)
Dimming control	14 V DC or 28 V DC

1.6.2 General data

Frequency range	118.000 MHz to 136.975 MHz (25 kHz mode)
Frequency range	118.000 MHz to 136.9916 MHz (8.33+25 kHz mode)
Channel spacing	25 kHz or 8.33 kHz
Number of channels	760 (25 kHz mode) 2280 + 760 (8.33+25 kHz mixed mode)
Storage temperature range	-55 °C to +85 °C
Operating temperature range as per EUROCAE/RTCA ED-14E/DO-160E	-20 °C to + 55 °C short-time + 70 °C
Operating altitude as per EUROCAE/RTCA ED-14E/DO-160E	35,000 ft

Vibration as per
 EUROCAE/RTCA ED-14E/DO-160E

Category S (Curve M) + Category U (Curve G)

1.6.3 Dimensions & Weight

Front panel	61.2 mm x 61.2 mm
Depth of unit	211.4 mm (front plate till end of antenna connector)
Mounting (backpanel)	standard 58 mm diameter (2 1/4 inch)
Material of Case	ALMg
Surface treatment	control head coated with black matt paint
Weight	850 g

1.6.4 Receiver data

Sensitivity	≤ -101 dBm for a (S+N)/N ratio of 6 dB (nominal) ≤ -93 dBm for a (S+N)/N ratio of 6 dB (qualified under environmental conditions)
Effective bandwidth (8.33 kHz channel)	$\geq \pm 2.78$ kHz at the 6 dB points $\leq \pm 7.37$ kHz at the 60 dB points
Effective bandwidth (25 kHz channel)	$\geq \pm 8$ kHz at the 6 dB points $\geq \pm 22$ kHz at the 60 dB points
Squelch	trigger level adjustable
AGC characteristic	≤ 6 dB in range -93 dBm to 0 dBm
Distortion $m = 85\%$	$\leq 15\%$
Audio frequency response relative to 1000 Hz	≤ 6 dB 350 Hz to 2500 Hz ≥ 35 dB at 4000 Hz
Rated output for speaker operation	≥ 4 W into 4Ω
Rated output power for headphone operation	≥ 300 mW into 150Ω ≥ 100 mW into 600Ω
Audio auxiliary input	1 V to 8 V (adjustable) across $600 \Omega \pm 10\%$

1.6.5 Transmitter data

Output power	≥ 6 W into 50Ω (with and without modulation)
Frequency tolerance	≤ 5 ppm
Duty cycle	1 minute (TX) : 4 minutes (RX)

AR6201

Type of modulation	A3E (amplitude modulation)
Modulation capability	≥ 70%
Distortion at 70% modulation	≤ 15%
Modulation bandwidth:	≤ 6 dB, 350 Hz to 2500 Hz
Dynamic microphone (with compressor)	1 ... 20 mV compressor starting point, adjustable Input balanced, 200 Ω Input range up to 30 dB above compressor starting point.
Standard microphone (with compressor)	10 ... 1000 mV compressor starting point, adjustable Input unbalanced, 150 Ω Input range up to 30 dB above compressor starting point.
FM deviation with modulation	≤ 3 kHz
Sidetone	adjustable
Automatic shutdown of transmit mode	120 seconds

1.6.6 Software

Nearly all functions inside the transceiver are controlled by microprocessors. The software is classified as Level D in accordance with EUROCAE/RTCA document ED12B/DO-178B.

1.6.7 Approval

ETSO	EASA.210.1249 ETSO 2C37e ETSO 2C38e
TSO	pending

1.7 Environmental Qualification

The following performance under environmental test conditions have been established in accordance with the procedures set forth in EUROCAE/RTCA Document ED-14E/DO-160E.

Condition	Section	Cat.	Description
Temperature and Altitude	4.0	C4	
Ground Survival Low Temperature	4.5.1		-55 deg C
Short-Time Operating Low Temperature			-20 deg C
Operating Low Temperature			-20 deg C
High Ground Survival Temperature	4.5.2		+85 deg C
High Short-Time Operating Temp.	4.5.3		+70 deg C
Operating High Temp.	4.5.4		+55 deg C
In-flight Loss of Cooling	4.5.5	X	No forced cooling required
Altitude	4.6.1	C4	35,000 ft
Decompression	4.6.2		
Overpressure	4.6.3		
Temperature Variation	5.0	B	5°C per minute
Humidity	6.0	A	Standard
Shock and Crash Safety	7.0	B	Fixed-wing and Helicopter, standard
Vibration	8.0	S U	Curve M for Fixed-wing Aircraft Curve G for Helicopters
Explosion proofness	9.0	X	N/A
Water proofness	10.0	X	N/A
Fluids Susceptibility	11.0	X	N/A
Sand and Dust	12.0	X	N/A
Fungus Resistance	13.0	X	N/A
Salt Spray	14.0	X	N/A
Magnetic Effect	15.0	Z	Less than 0.3m
Power Input	16.0	B	DC installations with battery of significant capacity
Voltage Spike	17.0	A	High degree of protection against voltage spikes
Audio Freq. Conducted Susceptibility	18.0	B	DC installations with battery of significant capacity
Induced Signal Susceptibility	19.0	AC	Primary power DC or AC, 400Hz
Radio Frequency Susceptibility	20.0	SW	Interim High Intensity Radiated Fields

AR6201

Condition	Section	Cat.	Description
Emission of Radio Frequency Energy	21.0	B	Equipment where interference should be controlled to a tolerable level
Lightning Induced Transients Susceptibility	22.0	A1E3X	Pin test waveform A, level 1 Cable bundle test waveform E, level 3
Lightning Direct Effects	23.0	X	N/A
Icing	24.0	X	N/A
Electrostatic Discharge	25.0	A	Equipment operated in an aerospace environment
Fire, Flammability	26.0	X	N/A

1.8 Accessories

Connector Kit CK4201-S (soldering version) Article-No.: 0879.304-954

consisting of:

25-pol. cable connector, soldering F	Article no. 0725.021-277
Connector housing	Article no. 0775.479-277
Antenna plug	Article no. 0725.706-277
Label "COMM"	Article no. 0711.111-258

Connector Kit CK4201-C (crimp version) Article-No.: 0514.901-954

consisting of:

25-pol. cable connector, crimp F	Article no. 0472.921-277
Connector housing	Article no. 0775.479-277
Antenna plug	Article no. 0725.706-277
Label "COMM"	Article no. 0711.111-258

Connector Kit CK6200-S (soldering version) Article-No.: 0617.903-954

consisting of:

25-pol. cable connector, soldering F	Article no. 0725.021-277
25-pol. cable connector, soldering M	Article no. 0726.331.277
2 X Connector housing	Article no. 0775.479-277
Antenna plug	Article no. 0725.706-277
Label "COMM"	Article no. 0711.111-258



AR6201

Connector Kit CK6200-C (crimp version)

Article-No.: 0617.891-954

consisting of:

25-pol. cable connector, crimp F

Article no. 0472.921-277

25-pol. cable connector, crimp M

Article no. 0891.551-277

2 X Connector housing

Article no. 0775.479-277

Antenna plug

Article no. 0725.706-277

Label "COMM"

Article no. 0711.111-258

Documentation

Operating instructions

Article no. 0618.764-071

Manual Installation and Operation

Article no. 0617.857-071

Manual Maintenance and Repair

Article no. 0617.865-071

Table of contents

Section	2	Installation	Page
2.1		General	1
2.2		Testing before Installation	1
2.3		Mechanical Installation	1
2.4		Electrical Interface	3
2.4.1		Connectors and Pin Assignment	3
2.4.2		Inputs / Outputs detailed Description	5
2.5		Installation Wiring	8
2.5.1		Typical Wiring for Single Seater Glider	9
2.5.2		Typical Wiring for Single Seater Glider (5-pol DIN Jack)	10
2.5.3		Typical Wiring for Twin Seater Motor Glider	11
2.5.4		Typical Wiring for usage of Standard Headsets	12
2.5.5		Typical Wiring for Aircrafts with Intercom System (Unbalanced)	13
2.5.6		Typical Wiring for Aircrafts with Intercom System (Balanced)	14
2.6		Location of internal automatic fuse	15
2.7		Installation Setup	15
2.7.1		Entering Installation Setup	15
2.7.2		Leaving Installation Setup	16
2.7.3		Page Up / Page Down in the Installation Setup	16
2.7.4		Storing of Setup Data	16
2.7.5		Installation Setup Pages – Data Description	16
2.8		Typical Settings in Installation Setup	22
2.8.1		Single Seater Glider	22
2.8.2		Twin Seater Motor Glider	22
2.8.3		GA aircraft using Standard Microphones	22
2.9		Retrofitting an AR4201 with an AR6201	23
2.9.1		Pin Compatibility	23
2.9.2		Dynamic Microphone Input	24
2.9.3		Temperature Sensor	25
2.9.4		RS-232 Interface	25
2.9.5		AFCU/AGC/AFWB	25
2.9.6		+13.75V Switched	25
2.10		Testing after Installation	26
2.10.1		Ground test with engine shut down	26
2.10.2		Ground test with engine running	26
2.11		Continued Airworthiness	26



AR6201

Blank

Section 2 INSTALLATION

2.1 General

The installation of the VHF transceiver depends on the type of aircraft and its equipment. Therefore, only general information can be given in this section.

The VHF transceiver is designed as a single block unit for usage in cockpit environment of general aviation aircrafts including helicopters under consideration of performed environmental qualification (refer chapter 1.7) and SW Level (refer chapter 1.6.6). For guidance also refer AC23.1309.

Notice:

Changes or modifications made to this equipment not expressly approved in written form by Becker Flugfunkwerk may void the authorization to operate this equipment.

2.2 Testing before Installation

General

Before installing the VHF transceiver in an aircraft, inspect the unit for marks of transport damage.

Visual examination

Before commissioning, visually examine the unit paying particular attention to the following:

- (1) Dirt, dents, scratches, corrosion or broken attaching parts, damaged paintwork on housing, parts of the housing and panel.
- (2) Dirt or scratches on the identification plate, front panel, LCD or inscriptions.
- (3) Dirt, bent or broken pins, displaced inserts of plugs and sockets.
- (4) Dirt and mechanical damage to push buttons and operating knobs.

2.3 Mechanical Installation

The VHF transceiver is designed for installation in the instrument panel of an aircraft. It is constructed for mounting from behind the panel by means of four screws, which are included in the delivery. The circular cutout and the mounting holes are to be drilled in accordance with the instrument size. The mounting point shall be at least 30 cm away from the aircraft magnetic compass, to avoid any interference to the magnetic compass by the transceiver. The dimensions are given in Figure 2-1.

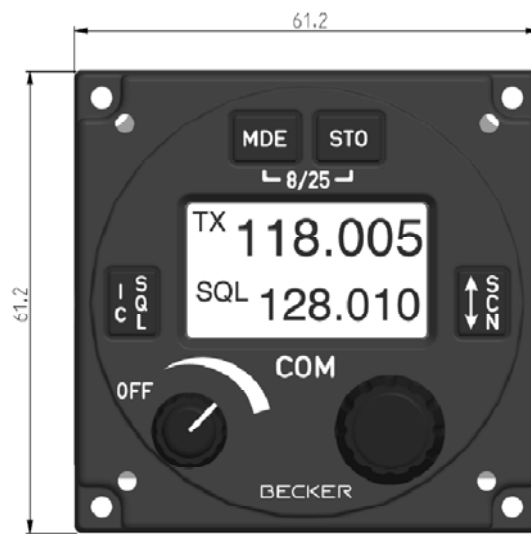

Figure 2-1 Mounting dimensions VHF transceiver

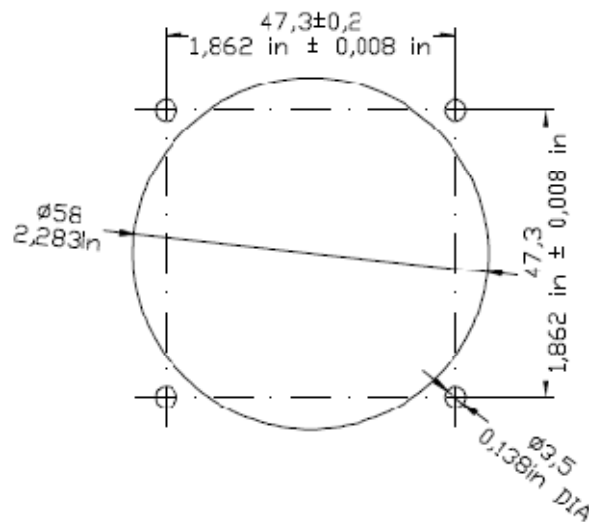

Figure 2-2 Drilling jig for back-panel mounting

2.4 Electrical Interface

2.4.1 Connectors and Pin Assignment

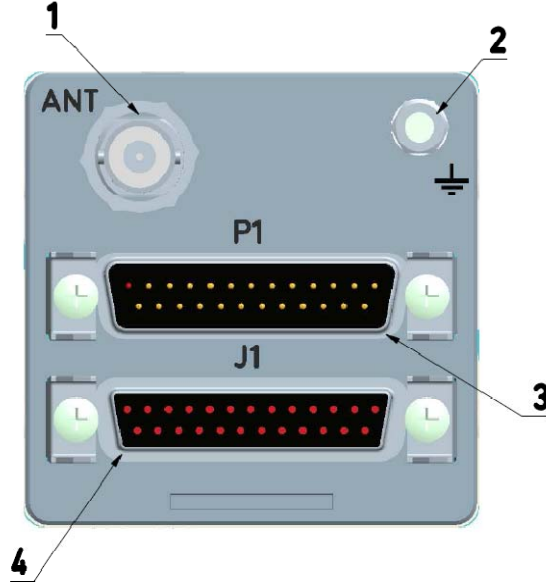

Figure 2-3 Connectors on Back plate

Antenna Connector (J3)

The antenna connector (Figure 2-3, Position 1) is a BNC type. The antenna port is designed for working with a nominal impedance of 50 Ohm.

Grounding Bolt (Position 2)

The transceiver has a M4 threaded grounding bolt (Figure 2-3, Position 2) allowing a low impedance grounding of the unit. A low impedance grounding is essential to avoid damage or malfunction in case of indirect lightning, EMI and HIRF conditions.

P1 Connector (System Interfaces)

The P1 connector (Figure 2-3, Position 3) is a D-SUB male connector with 25 pins and slide-in fastener.

Pin No.	Pin Name	Direction	Function
P1-1	SPK_HI	OUT	Speaker output signal (hot)
P1-2	HDPH_A	OUT	Balanced Output for Headphone(s)
P1-3	HDPH_B	OUT	Balanced Output for Headphone(s)
P1-4	AF_AUX_IN_HI	IN	Auxiliary audio input (hot)
P1-5	MIKE_DYN_HI	IN	Balanced input for dynamic microphone(s)
P1-6	MIKE_DYN_LO	IN	Balanced input for dynamic microphone(s)
P1-7	IC	IN	Intercom key input; ACTIVE state - closed contact to GND
P1-8	MIKE_STD_LO	-	Standard Microphone Low (ground/return)

Pin No.	Pin Name	Direction	Function
P1-9	NC		not connected
P1-10	ILL_LO	IN	Illumination low input
P1-11	P_SUPP	IN	Power supply Hot (positive)
P1-12	P_SUPP	IN	Power supply Hot (positive)
P1-13	P_SUPP_GND	-	Power supply Ground (return)
P1-14	SPK_LO	-	Speaker ground (return)
P1-15	LINE_OUT	OUT	High Impedance audio output
P1-16	AGC_OUT	OUT	Receiver AGC output
P1-17	/PTT	IN	Press To Talk key input ACTIVE state - closed contact to GND
P1-18	MIKE_STD_HI	IN	Standard Microphone High (hot)
P1-19	CPIN	-	Pin removed to allow mechanical coding of the harness connector.
P1-20	NC	-	not connected
P1-21	AF_AUX_IN_LO	-	Auxiliary audio input low (ground/return)
P1-22	NC	-	-
P1-23	ILL_HI	IN	Illumination high
P1-24	/PWR_EVAL	-	Power on Monitor output
P1-25	P_SUPP_GND	-	Power supply Ground (return)

J1 Connector (Serial Interfaces and Discrete I/Os)

The J1 connector is a D_SUB female connector with 25 pins and slide-in fastener.

Pin No.	AR6201 Pin Name	Direction	Function
J1-1	CPIN	-	Reserved Coding PIN
J1-2	TX2+	IN	Interface 2 OUT+
J1-3	RX2+	IN	Interface 2 IN+
J1-4	/SQL_EVAL	out	Squelch monitor output ACTIVE state - closed contact to GND
J1-5	/CSDB_EXT	IN	Extended CSDB protocol enabling ACTIVE state - closed contact to GND
J1-6	SHIELD_1	-	Interface 1 SHIELD
J1-7	TX1+	OUT	Interface 1 OUT+
J1-8	RX1+	IN	Interface 1 IN+
J1-9	TX2-	OUT	Interface 2 OUT-
J1-10	RX2-	IN	Interface 2 IN-
J1-11	SHIELD_2	-	Interface 2 SHIELD
J1-12	/EXT_SO	IN	External "Exchange" key Falling edge will activate frequency exchange

Pin No.	AR6201 Pin Name	Direction	Function
J1-13	/SRV_EN	IN	Service enable pin ACTIVE state - closed contact to GND
J1-14	TX1-	OUT	Interface 1 OUT-
J1-15	RX1-	IN	Interface 1 IN-
J1-16	NC		not connected
J1-17	NC		not connected
J1-18	NC		not connected
J1-19	NC		not connected
J1-20	(/GPI)	IN	General Purpose Input pin (unused, for future purposes) ACTIVE state - closed contact to GND
J1-21	D_GND	-	Discrete lines ground
J1-22	D_GND	-	Discrete lines ground
J1-23	D_GND	-	Discrete lines ground
J1-24	/MIKE_SW	IN	Microphone type selector input External enable/disable speaker
J1-25	/ON	IN	External Power ON input ACTIVE state - closed contact to GND

2.4.2 Inputs / Outputs detailed Description

Microphone Connection – Standard Microphone

Pin No.	AR6201 Pin Name	Direction	Function
P1-8	MIKE_STD_LO	-	Standard Microphone Low (ground/return)
P1-18	MIKE_STD_HI	IN	Standard Microphone High (hot)

For interfacing with standard microphone(s) the transceiver has an unbalanced input with an input impedance of 110 Ohm and a nominal sensitivity of 110 mV. This sensitivity level can be changed in the installation setup from 10 mV to 1000 mV. The power supply delivered from this pins for supply of the connected microphone(s) is 10.5 V DC, open circuit with an output impedance of 120 Ohm.

For all popular microphones the power supply is capable to supply two microphones in parallel. Care should be taken to combine only microphones of the same type.

It is highly recommended to mount the jacks isolated from aircraft frame in order to avoid ground loops.

Microphone Connection - Dynamic Microphone

Pin No.	AR6201 Pin Name	Direction	Function
P1-5	MIKE_DYN_HI	IN	Balanced input for dynamic microphone(s)
P1-6	MIKE_DYN_LO	IN	Balanced input for dynamic microphone(s)

For interfacing with dynamic microphone(s) the transceiver has a balanced input with an impedance of 140 Ohm and a nominal sensitivity of 1.6 mV. This sensitivity level can be changed in the installation setup from 1 mV to 20 mV.

Two dynamic microphones (of the same type) may be connected in parallel.

It is highly recommended to mount the jacks isolated from aircraft frame in order to avoid ground loops.

Speaker Connection

Pin No.	AR6201 Pin Name	Direction	Function
P1-1	SPK_HI	OUT	Speaker output signal
P1-14	SPK_LO	-	Speaker ground (return)

The speaker output provides nominal 4 Watts into 4 Ohm.

CAUTION :

The magnetic field of a speaker influences the magnetic compass. When choosing the mounting point, a distance of not affecting the magnetic compass must be determined. After speaker installation accuracy of compass operation must be proofed.

Headphone connection

Pin No.	AR6201 Pin Name	Direction	Function
P1-2	HDPH_A	OUT	Balanced Output for Headphone(s)
P1-3	HDPH_B	OUT	Balanced Output for Headphone(s)

The headphone output is a balanced, transformer coupled output providing nominal 300 mW into 150 Ohm.

Up to two headphones with self-impedance of 300 Ohm (or higher) may be connected in parallel.

Because the headphone output is balanced but in installations the use of a single shielded wire for headphone is very popular, P1-3 can be grounded (connection to pin P1-13/P1-25). In this way the balanced output become unbalanced.

It is highly recommended to mount the jacks isolated from aircraft frame in order to avoid ground loops.

Panel Illumination

Pin No.	AR6201 Pin Name	Direction	Function
P1-10	ILL_LO	IN	Illumination low input
P1-23	ILL_HI	IN	Illumination high

The VHF transceiver is fitted with an illumination for push-buttons and LCD display. In the installation setup it can be configured if this illumination will be controlled via front panel or externally via pin P1-10/P1-23

Connect ILL_LO (pin P1-10) to system ground. Connect ILL_HI (pin P1-23) to dimming voltage bus.

“Auxiliary” audio input

Pin No.	AR6201 Pin Name	Direction	Function
P1-4	AF_AUX_IN_HI	IN	Auxiliary audio input
P1-21	AF_AUX_IN_LO	-	Auxiliary audio input ground

The AF auxiliary input enables to connect an external audio source (NAV, music-player ...) to the transceiver. The external audio will be audible only when transceiver works in receive operation.

AR6201

The sensitivity can be adjusted in the installation setup from 1 to 8 V.
The input impedance of this input is 10 kΩ.

/PTT (Press to talk)

Pin No.	AR6201 Pin Name	Direction	Function
P1-17	/PTT	IN	Press To Talk key input ACTIVE state - closed contact to GND

The transceiver will go to transmit operation, if this input is connected to ground.
This input has an internal pull up. If input is connected to ground a current of below 1 mA will flow.

IC (External Intercom key)

Pin No.	AR6201 Pin Name	Direction	Function
P1-7	IC	IN	Intercom key input; ACTIVE state - closed contact to GND

The transceiver will provide intercom operation, if this input is connected to ground.
This input has an internal pull up. If input is connected to ground a current of 1 mA will flow.

In most installations this input will not needed to be connected, because the intercom operation can automatically be activated via VOX. Only in very rare cases where the VOX will not work satisfactorily (very loud cockpit environment) it makes sense to uses this input for manual activation.

/MIKE_SW (Mike Switch)

Pin No.	AR6201 Pin Name	Direction	Function
J1-24	/MIKE_SW	IN	Microphone type selector input External enable/disable speaker

Depending on installation setup this input has several functions.

- This input may enable/disable the Speaker
- This input may enable/disable the VOX
- This input may select the microphone input (Standard Microphone / Dynamic Microphone)

Install. Setup Page MIKE TYPE	Install. Setup Page CONFIG ENABLE SPEAKER	/MIKE_SW	VOX Status	Speaker Status	Selected Mike input
Set to: STANDARD or DYNAMIK or BOTH MIKES	NO	Open	As set by User	disabled	As selected in setup **)
	Don't care *) YES	GND	Forced Off	enabled	
HW SELECT	Don't care *)	Open	As set by User	disabled	Standard Mike
	Don't care *)	GND	Forced Off	enabled	Dynamic Mike
HW SELECT INV	Don't care *)	Open	Forced Off	enabled	Dynamic Mike
	Don't care *)	GND	As set by User	disabled	Standard Mike

- *) Don't care means that setting is ignored and has no influence to the device behavior.
- ***) If STD MIKE is selected only Standard Microphone Input is active.
 If DYN MIKE is selected only Dynamic Microphone Input is active.
 If BOTH MIKES is selected Standard Microphone Input and Dynamic Microphone Input are active and will be mixed.

/PWR_EVAL

Pin No.	AR6201 Pin Name	Direction	Function
P1-24	/PWR_EVAL	-	Power on Monitor output

This output indicates if the transceiver is switched on or switched off. It is an open collector output type. The output is internally connected to ground when the unit is switched on. In this case a current of maximum 100 mA can flow into the transceiver to drive for example an external relay. The output has high impedance when the unit is switched off. Refer Figure 2-4 for further guidance.

Note: When connecting an external relay, a protection diode shall be connected in parallel to the relay in order to avoid damage of this output.

2.5 Installation Wiring

Typical installation wiring diagrams are shown in Figure 2-4 to Figure 2-9.

Notes:

- (1) Use only cable which is fit for aircraft use (self extinguishing). AWG 20 for power supply and AWG 22 for other cables.
- (2) Fit sleeves over the solder joints on the equipment connector. Crimp connectors are also available from Becker.
- (3) Protect the power supply with a 7.5 A fuse or circuit breaker.
 The VHF transceiver is protected internally by a 5 A resettable fuse.
- (4) Type-specific cable harnesses are also available for the aircraft wiring (details from the manufacturer).
- (5) No HF cables should be included in the cable harnesses of the system. The routing of connecting cables alongside cables which carry audio power or pulses should also be avoided.
- (6) Check the wiring carefully before switching on the unit and check particularly that power supply lines have not been reversed.

2.5.1 Typical Wiring for Single Seater Glider

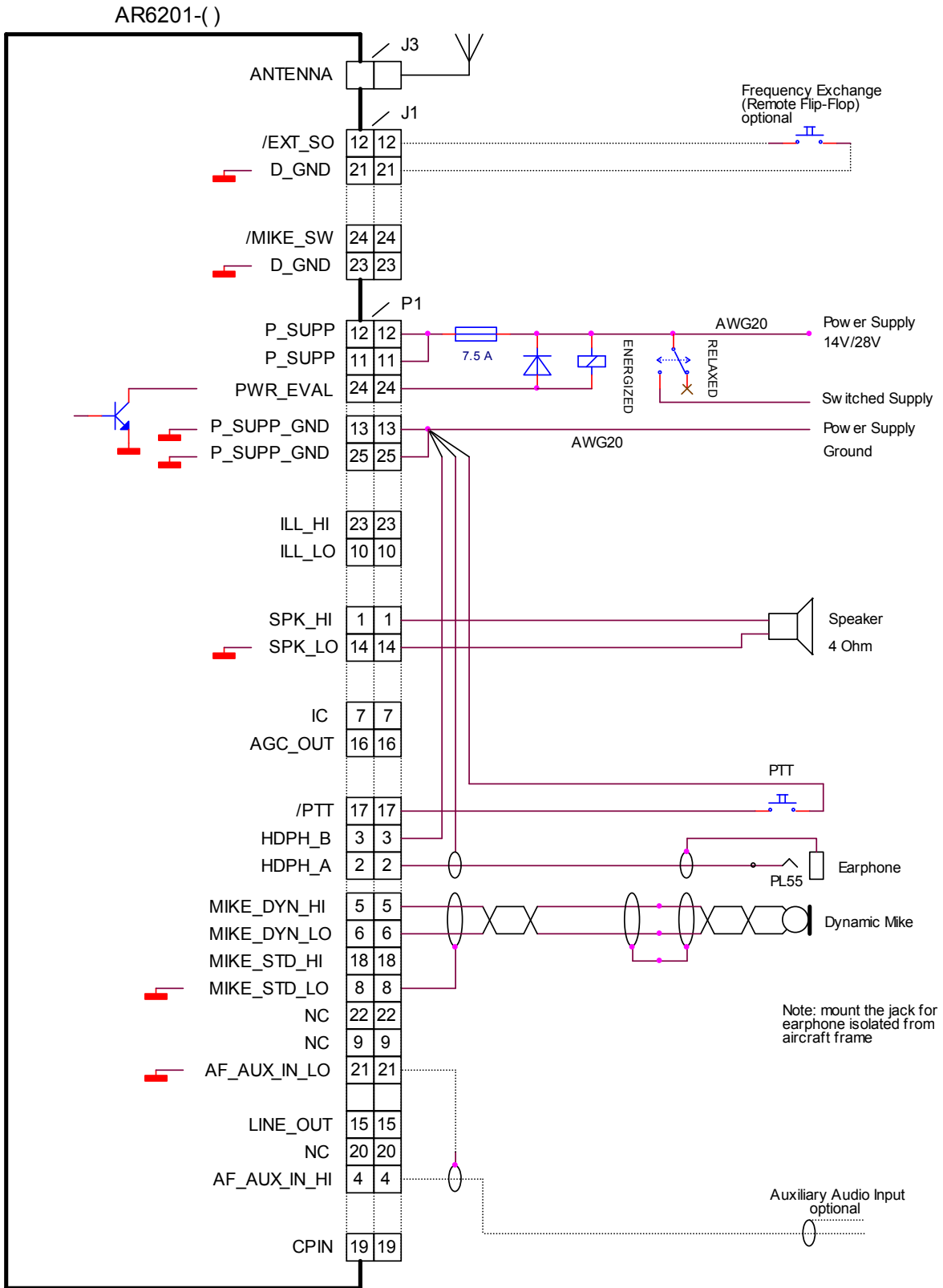

Figure 2-4 Typical Wiring for Single Seater Glider

2.5.2 Typical Wiring for Single Seater Glider (5-pol DIN Jack)

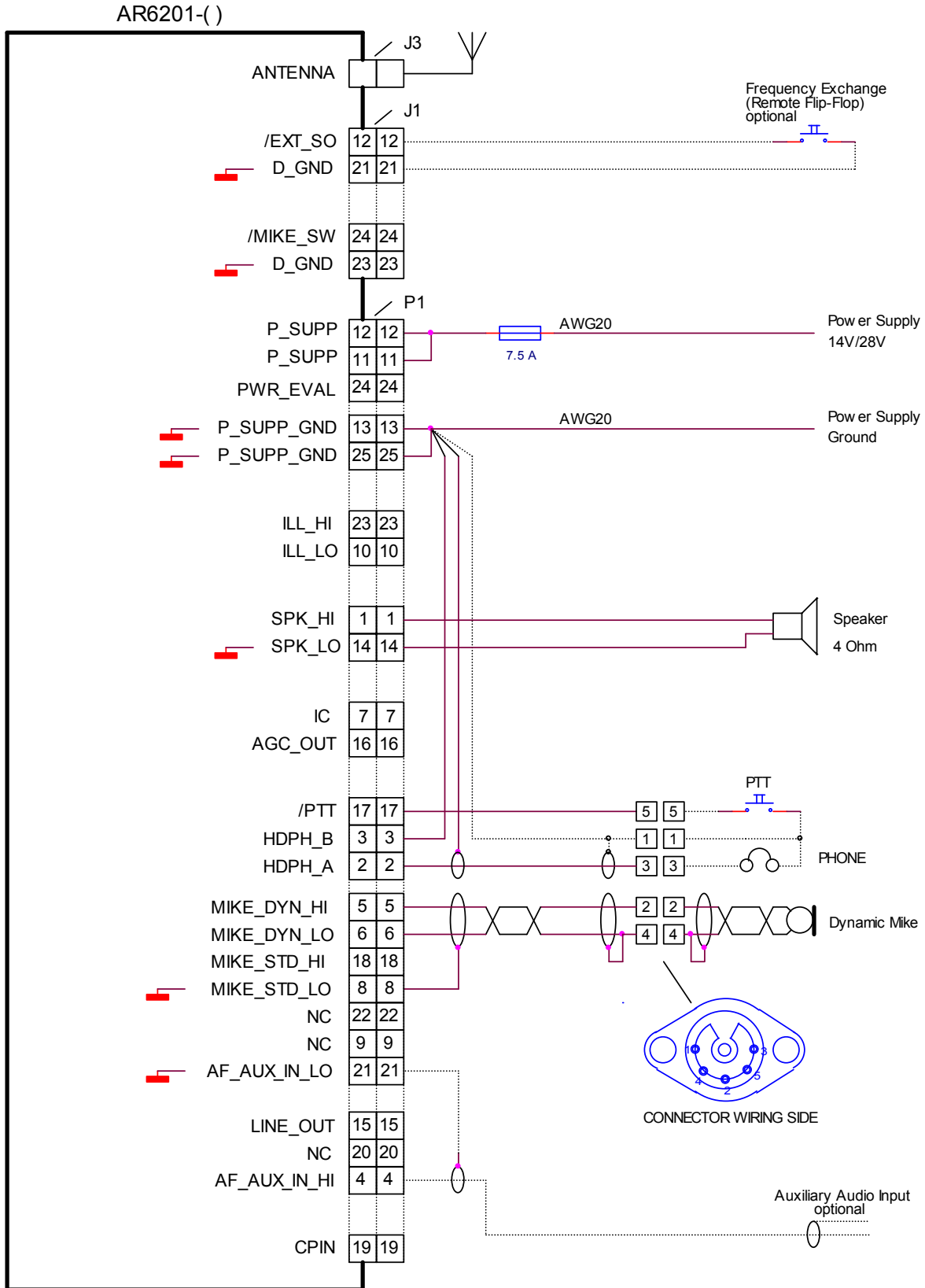

Figure 2-5 Typical Wiring for Single Seater Glider (5-pol DIN Jack)

2.5.3 Typical Wiring for Twin Seater Motor Glider

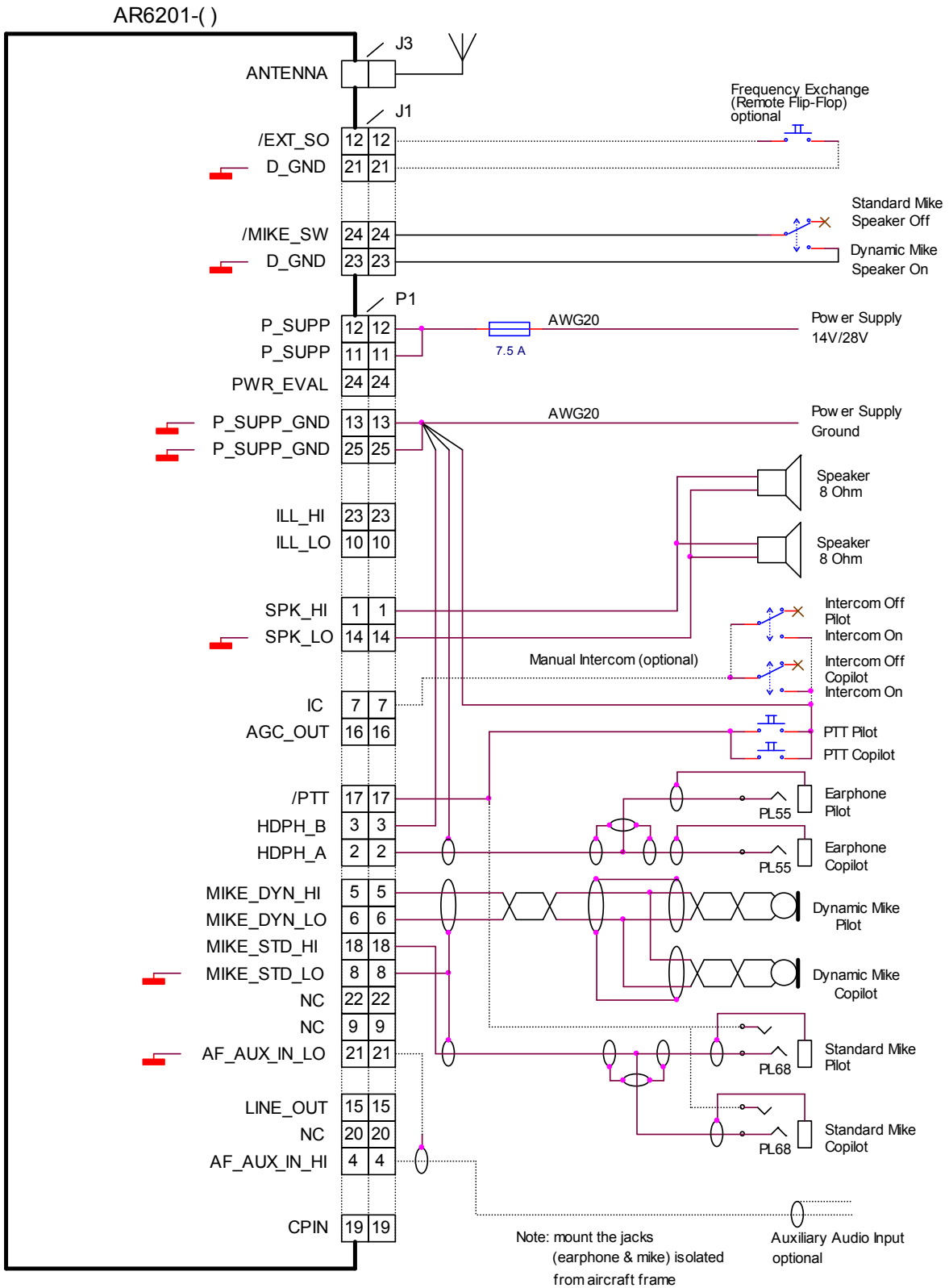

Figure 2-6 Typical Wiring for Twin Seater Motor Glider

2.5.4 Typical Wiring for usage of Standard Headsets

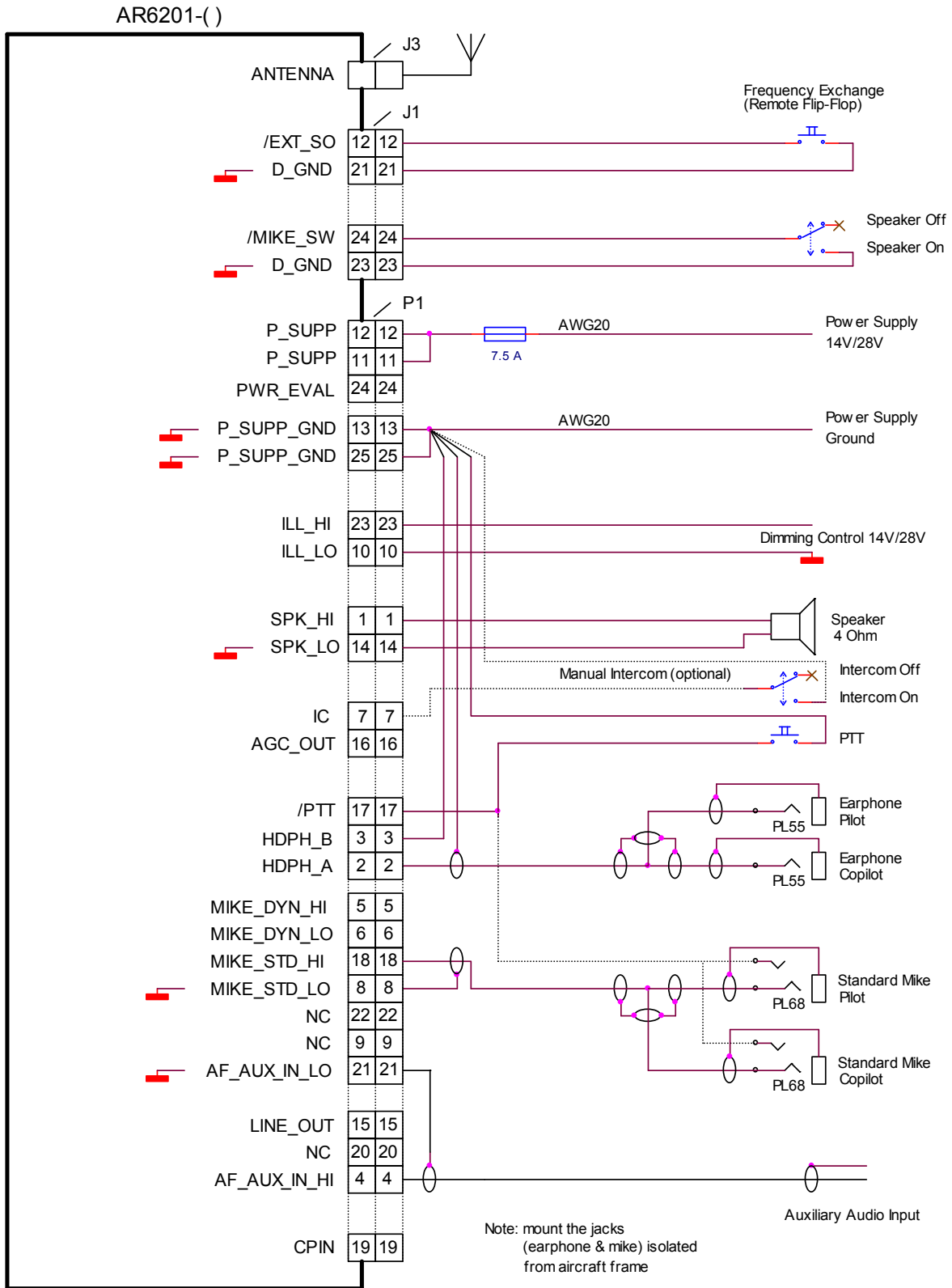

Figure 2-7 Typical Wiring for usage of Standard Headsets

2.5.5 Typical Wiring for Aircrafts with Intercom System (Unbalanced)

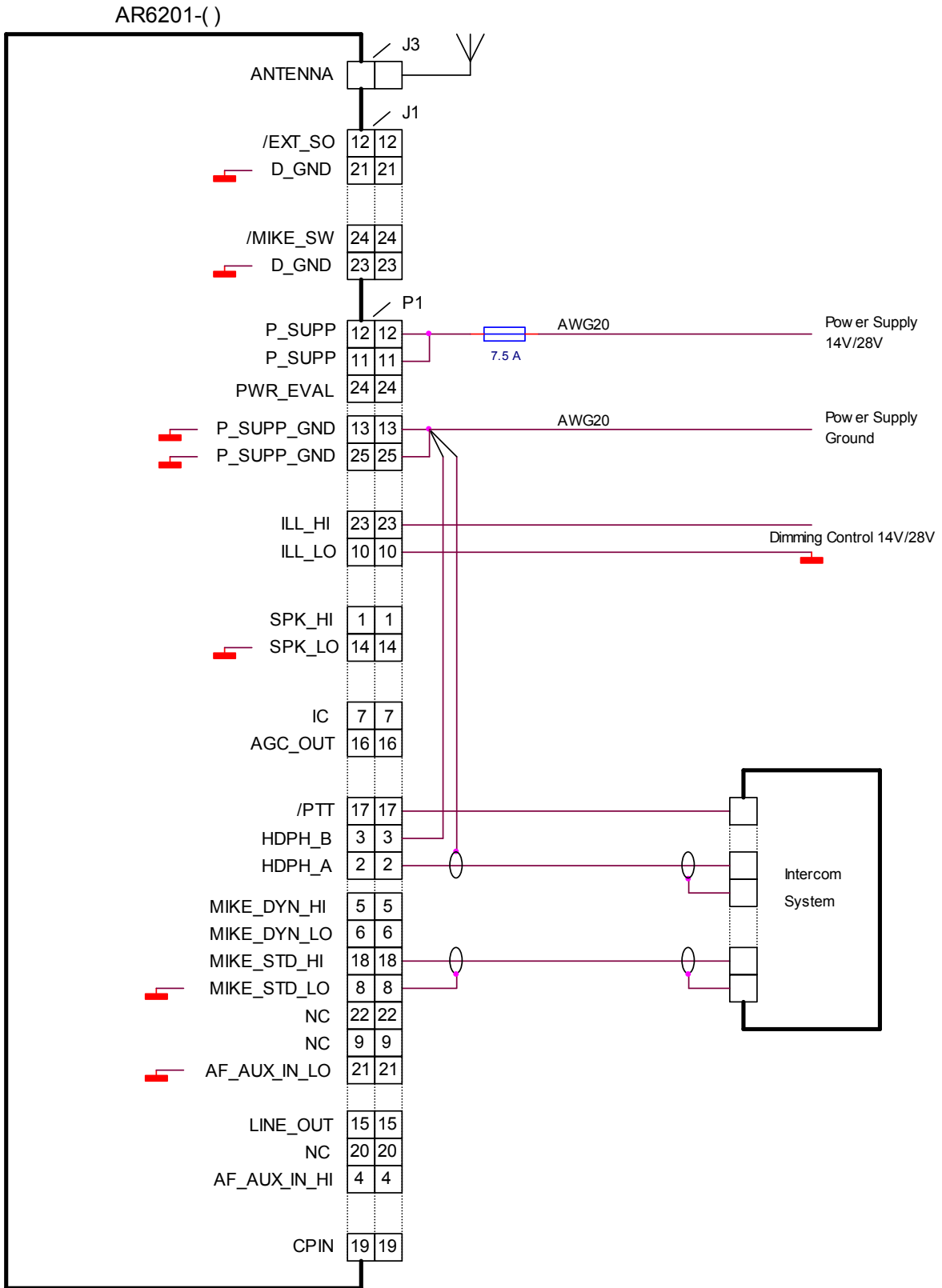

Figure 2-8 Typical Wiring for Aircrafts with Intercom System (Unbalanced)

2.5.6 Typical Wiring for Aircrafts with Intercom System (Balanced)

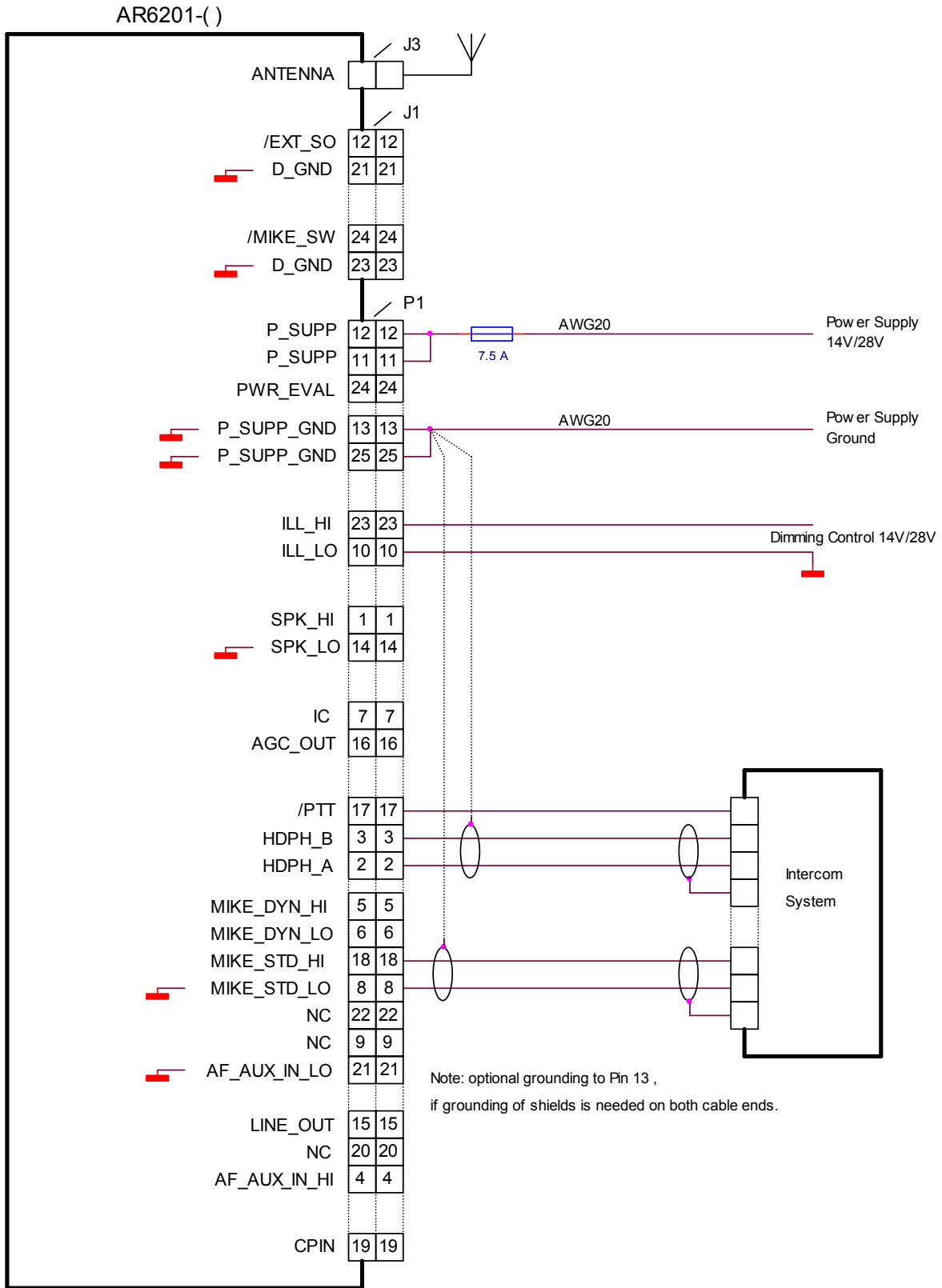

Figure 2-9 Typical Wiring for Aircrafts with Intercom System (Balanced)

2.6 Location of internal automatic fuse

The internal automatic fuse is to be reseted by means of a matching plastic tool (may be self made).

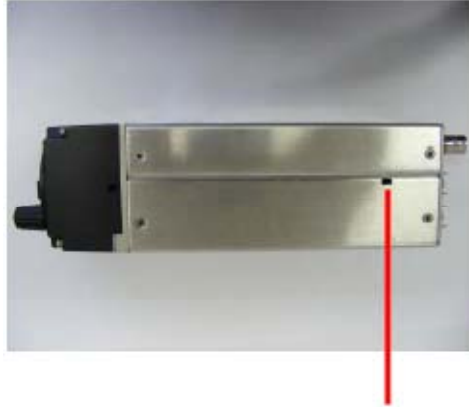

Figure 2-10 Location of internal automatic fuse

2.7 Installation Setup

2.7.1 Entering Installation Setup

The installation setup is meant to enable the ground technicians to set the equipment configuration and must not be used in flight. The installation setup is activated when the "MDE" key is pressed while the transceiver is switched ON. The following screen will appear:



Setup indication

After pressing any key the transceiver will ask for a password.

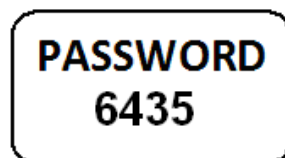

Password Dialog

Set the 4-digit numerical code password "**6435**" using "rotary encoder" and push button of the "rotary encoder".

Confirm by pressing the "STO" key.

Now the first page of installation setup will be shown as follows:

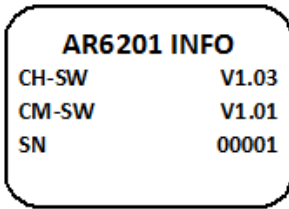

2.7.2 Leaving Installation Setup

The installation setup can be left just by switching off the transceiver. All changes done up to that time are stored automatically.

2.7.3 Page Up / Page Down in the Installation Setup





The installation setup consists of several pages.
 By pressing "↑/SCN" key the next page will be displayed.
 By pressing "↓/SQL" key the previous page will be displayed.

2.7.4 Storing of Setup Data

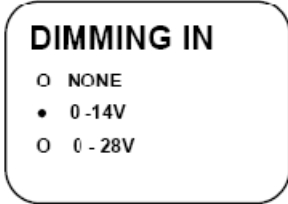

The settings of a parameter are stored immediately after changing the parameter. No special actions are needed for storing before leaving a page or leaving the setup.

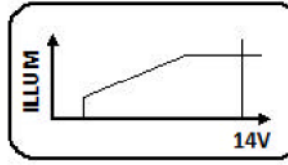

2.7.5 Installation Setup Pages – Data Description

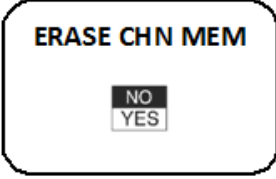
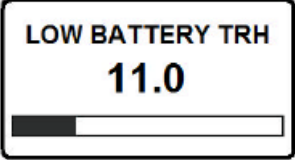
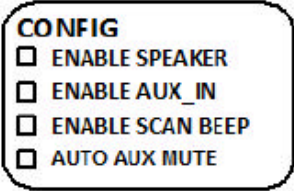

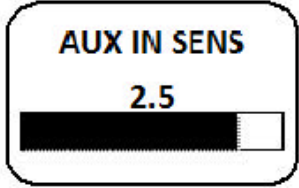
Display Contents	Description
	This is the first page, which is displayed after entering installation setup. This page displays information about the SW versions and the serial number of the transceiver.

Display Contents	Description
 <p>DIMMING IN</p> <ul style="list-style-type: none"> <input type="radio"/> NONE <input checked="" type="radio"/> 0-14V <input type="radio"/> 0-28V 	<p>One of the three following options may be selected for the dimming input:</p> <p><u>NONE:</u> The illumination for LCD and push-buttons will be controlled via the rotary encoder on the transceiver itself. pilot can change the dimming in the pilots menu (refer chapter 3.12.2). This option will be selected in aircrafts where a dimming bus is not available.</p> <p><u>0-14V:</u> The illumination for LCD and push-buttons will be controlled (via pin P1-10/P1-23) by the dimming bus of the aircraft. The dimming voltage is in range 0 ... 14 V DC</p> <p><u>0-28V:</u> The illumination for LCD and push-buttons will be controlled (via pin P1-10/P1-23) by the dimming bus of the aircraft. The dimming voltage is in range 0 ... 28 V DC</p> <p>Select your option by turning rotary encoder and pressing "STO" push-button.</p>
 <p>BRIGHTNESS</p> <p>50%</p> <p>Note: This page is only displayed if dimming input is set to "NONE".</p>	<p>The brightness of the LCD and push-button illumination can be adjusted between 0% (off) and 100%.</p> <p>Note: The same adjustment will also be possible in the pilot setup, therefore this parameter can easily be changed by pilot later on.</p> <p>Select your brightness by turning rotary encoder.</p>
 <p>Note: This page is only displayed if Dimming Input is set to "14V or 28V" "14V" or "28V" is displayed depending on selection.</p>	<p>The illumination curve (relation between dimming voltage and brightness of the LCD and push-button illumination) can be adjusted on four points:</p> <ol style="list-style-type: none"> (1) Voltage V1 for starting of brightness increase. (below V1 brightness is 0). (2) Minimum brightness if V1 is just reached. (3) Voltage V2 for which maximum brightness is reached (above V2 brightness stays constant). (4) Maximum brightness. <p>This 4 points can be toggled by pressing the "STO" push-button.</p> <p>Adjustment of the points (left/right or up/down) can be done by turning the rotary knob.</p>
 <p>CHN MEM STORE</p> <p><input checked="" type="checkbox"/> ENABLE STORE</p>	<p>If enabled, the user can store manually frequencies as described in chapter 3.8.1.</p> <p>If disabled, the manual storing of frequencies is not possible.</p> <p>Enabling/Disabling can be toggled by pressing the "STO" push-button.</p>

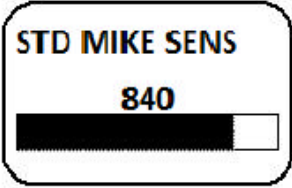
Display Contents	Description
	<p>By changing the option to “YES” (turn rotary knob) and pressing the “STO” push-button all stored frequencies will be deleted.</p>
	<p>If the supply voltage drops below the adjustable threshold (10 ... 33 V DC) the display indicates the message “LOW BATT”.</p> <p>The factory setting for that threshold is 10.5 V.</p> <p>The value shall be adjusted by the installer depending on the used battery type.</p> <p>The value can be adjusted by turning the rotary encoder.</p>
	<p>On this page four options are independent selectable.</p> <p><u>ENABLE SPEAKER</u> If ENABLE SPEAKER is activated, the same audio normally available on headphone output is also available on speaker output (Pin P1-1 / Pin P1-14). This setting is overwritten by MIKE configuration if “HW SELECT” or “INV. HW SELECT” is chosen. For guidance also refer to chapter 2.4.2, subpart /MIKE_SW.</p> <p><u>ENABLE AUX_IN:</u> By activating ENABLE AUX_IN the auxiliary audio input audio applied to pin P1-4 / pin P1-21 will be hearable on headphone / speaker. Note: If the auxiliary audio input is not used it is recommended to deactivate ENABLE_AUX_IN. This will reduce noise on speaker output.</p> <p><u>ENABLE SCAN BEEP:</u> By enabling SCAN BEEP the transceiver will generate (only in scan mode) a short “BEEP” to notify about a signal presence on preset channel, when automatically switching is not possible. By disabling SCAN BEEP no tone will be generated.</p> <p><u>AUTO AUX MUTE:</u> If AUTO AUX MUTE is activated then the auxiliary audio input will be muted if the receiver detects (based on squelch evaluation) a signal or user deactivate squelch. If AUTO AUX MUTE is deactivated then the auxiliary audio input signal will be continuously mixed with the receiver signal. Note: For using the AUTO AUX MUTE function, ENABLE AUX_IN has to be activated. Otherwise the setting will have no effect.</p> <p>Select your options by turning rotary encoder and pressing “STO” push-button.</p>

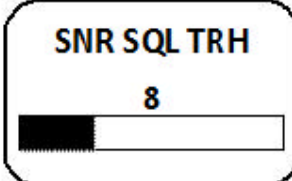
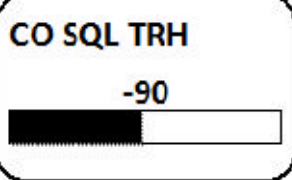
Display Contents	Description
 <p>Note: This page is only displayed if ENABLE_AUX_IN is activated.</p>	<p>The sensitivity of the Auxiliary Audio Input (Pin P1-4 / Pin P1-21) can be adjusted in the range 1.0 V to 8.0 V by turning the rotary knob.</p>
 <p>Note: The last selectable option (BOTH MIKES) is not visible on the screen shoot above. The option became visible by turning the rotary knob down (below DYNAMIC).</p>	<p>One of the five following options may be selected:</p> <p><u>HW SELECT:</u> The state of the input /MIKE_SW (Pin J1-24) switch will define which microphone input will be used. /MIKE_SW = open -> Standard Microphone /MIKE_SW = GND -> Dynamic Microphone</p> <p><u>HW SELECT INV:</u> The state of the input /MIKE_SW (Pin J1-24) switch will define which microphone input will be used. Like above but just inverted. /MIKE_SW = open -> Dynamic Microphone /MIKE_SW = GND -> Standard Microphone</p> <p><u>STANDARD:</u> The Standard Microphone input is selected regardless of the state of /MIKE_SW.</p> <p><u>DYNAMIC:</u> The Dynamic Microphone input is selected regardless of the state of /MIKE_SW.</p> <p><u>BOTH MIKES:</u> The audio signals of the Dynamic Microphone and Standard Microphone will be mixed together (regardless of the state of /MIKE_SW).</p> <p>Select your option by turning rotary encoder and pressing "STO" push-button.</p>

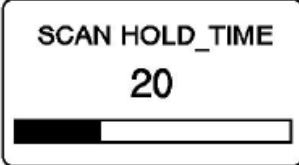
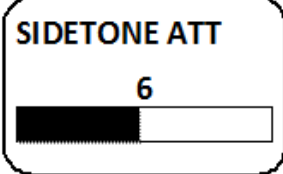
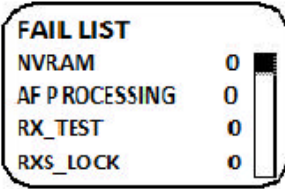
Display Contents	Description
 <p>Note: This page is only displayed if Standard Mike is active. In case that HW SELECT or HW SELECT INV had been chosen in page MIKE TYPE it may be needed to switch over the external mike switch in order to display this page.</p>	<p>The sensitivity of Standard Microphone Input can be adjusted in range from 10 mV to 1000 mV by turning the rotary knob. The factory setting is 110 mV.</p> <p>Note: The microphone sensitivity shall be adjusted to achieve a correct modulation by keeping the cockpit noise suppression as high as possible. If the sensitivity is adjusted to a very small value (e.g. 10 mV) the cockpit noises will be hearable more than for a higher adjustment (e.g. 100 mV). On the other side if the sensitivity is adjusted to a very high value (e.g. 1000 mV) the cockpit noise will be very small, but the modulation of the transmitter may be no sufficient. After modifying this parameter a communication check shall be done by the installer. It is recommended to perform this communication check with and without engine running.</p>
 <p>Note: This page is only displayed if Standard Mike is active. In case that HW SELECT or HW SELECT INV had been chosen in page MIKE TYPE it may be needed to switch over the external mike switch in order to display this page.</p>	<p>The sensitivity of Dynamic Microphone Input can be adjusted in range from 1 mV to 20 mV by turning the rotary knob. The factory setting is 1.6 mV.</p> <p>Note: The microphone sensitivity shall be adjusted to achieve a correct modulation by keeping the cockpit noise suppression as high as possible.</p>
	<p>The noise squelch can be adjusted in range of 6 to 26 by turning the rotary knob. <u>Minimum Adjustment of 6 means:</u> Also very weak and noisy signals will be audible. Squelch opens around -105 dBm <u>Maximum adjustment of 26 means:</u> Squelch will only enable audio for quite strong signals with low noise content. Squelch opens around -87 dBm Note: The same adjustment will also be possible in the pilot setup, therefore this parameter can easily be changed by pilot later on.</p>
	<p>The carrier overwrite squelch is adjustable in range of -95 dBm to -85 dBm. The factory setting is -87dBm. It is recommended not modifying this parameter.</p>

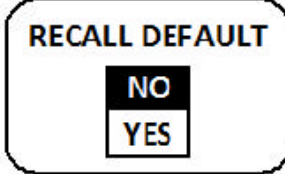
Display Contents	Description
	<p>The Scan Hold Time is adjustable in range of 1 to 20 seconds.</p> <p>The factory setting is 1 second It is recommended not modifying this parameter.</p>
	<p>The sidetone attenuation is adjustable in range 0 ... 12 dB by turning the rotary knob.</p> <p>This attenuation is related to the intercom volume. 0 = sidetone as loud as intercom signal. 12 = sidetone signal 12dB more silent than intercom.</p> <p>Note: If the intercom volume (refer chapter 3.12.1) is set to a very low value, also the sidetone will be quite silent, even if adjusted to 0 on this page.</p>
	<p>This page displays information about failures which had been stored in the memory. This page may be very helpful for trouble shooting and failure isolation.</p> <p>“0” means no failure had been detected. “1” means that an failure had been detected and stored.</p> <p>This page is for information purpose only.</p>
	<p>The stored failures (see previous page) may be erased by turning the rotary knob to “YES” and pressing the “STO” push-button.</p> <p>Erasing the failure list should be not done by the installer. The failure list will normally be deleted by factory or maintenance shop.</p>
	<p>The factory default settings are the settings as the equipment leaves the factory.</p> <p>The factory default settings can be restored by turning the rotary knob to “YES” and pressing the “STO” push-button.</p> <p>Note: <u>Restoring the factory default settings will overwrite all previous installation settings !</u></p>

2.8 Typical Settings in Installation Setup

2.8.1 Single Seater Glider

Typical Installation Wiring	Figure 2-4, Figure 2-5
Installation Setup: ENABLE SPEAKER	Activated
Installation Setup: MIKE TYPE	DYNAMIC
Remarks	Permanent crossed IC sign (X), because VOX is disabled

2.8.2 Twin Seater Motor Glider

Typical Installation Wiring	Figure 2-6
Installation Setup: ENABLE SPEAKER	State doesn't care
Installation Setup: MIKE TYPE	HW SELECT
Remarks	<p>The external switch (connected to pin J1-24) will have the following function:</p> <p>Open: Standard Microphone selected. Speaker disabled. Intercom via VOX possible.</p> <p>Closed: Dynamic Microphone selected. Speaker enabled. No Intercom via VOX possible. X is displayed.</p>

2.8.3 GA aircraft using Standard Microphones

Typical Installation Wiring	Figure 2-7
Installation Setup: ENABLE SPEAKER	Deactivated
Installation Setup: MIKE TYPE	STANDARD
Remarks	<p>The external switch (connected to pin J1-24) will have the following function:</p> <p>Open: Speaker disabled, Intercom via VOX possible.</p> <p>Closed: Speaker enabled No Intercom via VOX possible X is displayed.</p> <p>The Standard Microphone Input is selected regardless of the position of the external switch.</p>

2.9 Retrofitting an AR4201 with an AR6201

In most cases an AR4201 may be retrofitted by an AR6201 without any problems. However in some cases a problem may appear, because not all pins are full compatible.

2.9.1 Pin Compatibility

Pin No.	AR6201 Pin Name	AR4201 Function	AR4201 Pin Name	AR6201 Function	Full compatible
P1-1	AF-ASYM	Speaker output, unbalanced	SPK_HI	Speaker output, unbalanced	Yes
P1-2	AF-HI	Headphone output, balanced	HDPH_A	Headphone output, balanced	Yes
P1-3	AF-LO	Headphone output, balanced	HDPH_B	Headphone output, balanced	Yes
P1-4	AFAUX	Auxiliary audio input, unbalanced	AF_AUX_IN_HI	Auxiliary audio input, unbalanced	Yes
P1-5	MIKE DYN	Dynamic microphone input, high side, (unbalanced)	MIKE_DYN_HI	Dynamic microphone input, high side, (balanced)	Yes
P1-6	MIKE GROUND	Ground for dynamic microphone,	MIKE_DYN_LO	Dynamic microphone input, low side, balanced	No
P1-7	IC	Intercom input	IC	Intercom input	Yes
P1-8	TEMS1	Input for temperature sensor	MIKE_STD_LO	Ground	No
P1-9	RXD	RS232 RXD	NC	Not connected	No
P1-10	-ILLUMINATION	Illumination, low side	ILL_LO	Illumination, low side	Yes
P1-11	+13.75V	Positive power supply	P_SUPP	Positive power supply	Yes
P1-12	+13.75V	Positive power supply	P_SUPP	Positive power supply	Yes
P1-13	GROUND	Power supply return / Ground	P_SUPP_GND	Power supply return / Ground	Yes
P1-14	AF GND MIKE STD GND	Ground	SPK_LO	Ground	Yes
P1-15	AFCU	Normally not used in installation	LINE_OUT	Normally not used in installation	No
P1-16	AGC/AFWB	Normally not used in installation	AGC_OUT	Normally not used in installation	No
P1-17	PTT	Press to talk	/PTT	Press to talk	Yes

P1-18	MIKE STD.	Standard microphone input, high side, unbalanced	MIKE_STD_HI	Standard microphone input, high side, unbalanced	Yes
P1-19	CPIN	coding pin (removed pin)	CPIN	coding pin (removed pin)	Yes
P1-20	TEMS2	Ground for Temperature sensor	NC	Not connected	No
P1-21	GNDDATA	Ground	AF_AUX_IN_LO	Ground	Yes
P1-22	TXD	RS232 TXD	NC	Not connected	No
P1-23	+ILLUMINATION	Illumination, high side	ILL_HI	Illumination, high side	Yes
P1-24	+13.75V SWITCHED	Power on monitor Switched positive power supply.	/PWR_EVAL	Power on monitor Open collector output. GND if On.	No
P1-25	GROUND	Power supply return / Ground	P_SUPP_GND	Power supply return / Ground	Yes

2.9.2 Dynamic Microphone Input

By retrofitting AR4201 with the AR6201 in a typical glider installation with a dynamic microphone, the situation will look like shown in figure below:

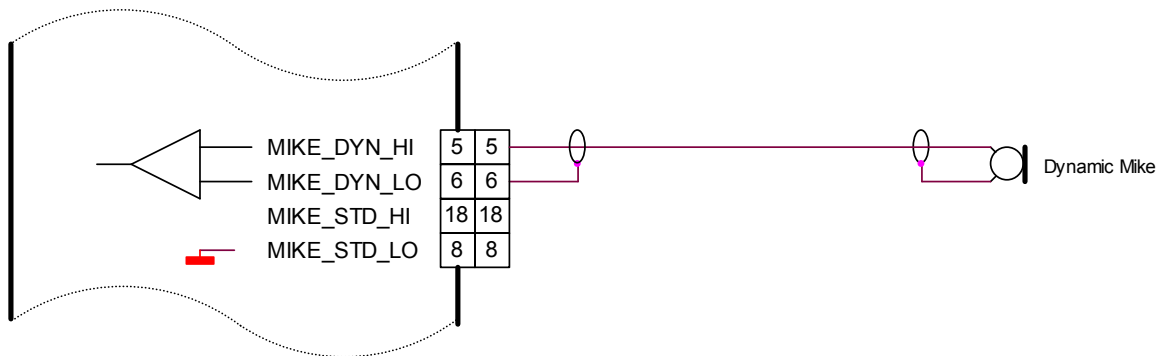

The cable shield is connected with pin P1-6, which is the low side input for dynamic microphone. Because in AR6201 this input is balanced, the cable shield is not any more connected to ground (like it was case with the AR4201). In most cases this will not generate a problem. In cases a problem is detected with distortions coupling into the microphone signal the following modification is recommended:

Connect Pin P1-6 with Pin P1-8 (In this way the cable shield will be grounded). This connection is shown in following figure:

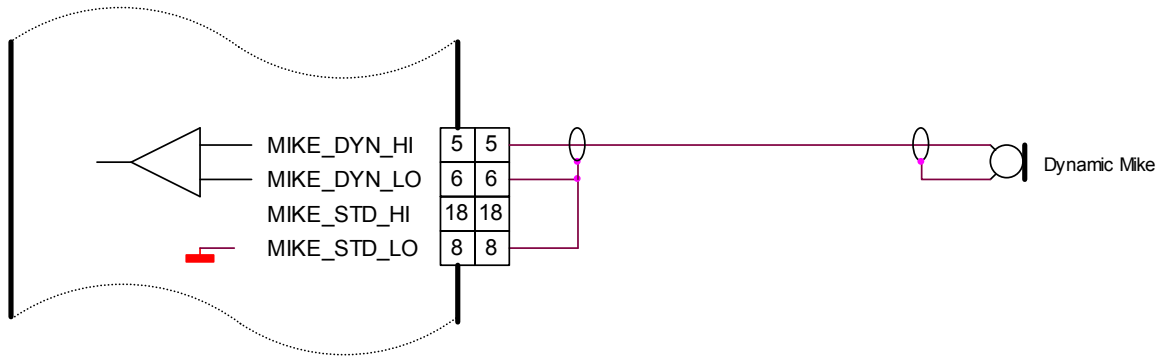

2.9.3 Temperature Sensor

The AR6201 does not have a temperature sensor input. But a temperature sensor connected between pin P1-8 and pin P1-20 (from previous installation) will not negatively affect the operation of the transceiver.

2.9.4 RS-232 Interface

The AR6201 does not have a RS-232 interface for remote control. But a RS-232 signal connected to pin P1-9 or pin P1-22 (from previous installation) will not negatively affect the operation of the transceiver.

2.9.5 AFCU/AGC/AFWB

Pin P1-15 and Pin P1-16 are normally not used in aircraft installations. Therefore the slightly different functions of these pins should not cause any problem.

2.9.6 +13.75V Switched

The AR6201 provides on pin P1-24 a low signal when the unit is switched on and a high impedance signal, when switched off (refer chapter 2.4.2). This is not compatible to the AR4201, which provided a positive power supply when switched on and a high impedance when switched off.

In cases it is needed to switch on and off a slave equipment together with switching on and off the transceiver connect a relay on pin P1-24 as shown in Figure 2-4.

2.10 Testing after Installation

2.10.1 Ground test with engine shut down

After installation of the unit, measure the antenna tuning using a VHF reflection-coefficient meter (voltage standing wave meter).

The VSWR (voltage standing wave ratio) over the complete frequency range of the unit shall be within 3:1. If this matching value is exceeded it indicates a mismatch, caused for example by an incorrect or unsatisfactory counterpoise, a cable with an impedance which deviates significantly from 50 Ohm or an incorrectly tuned antenna, or faults on the BNC connectors of the antenna cable.

2.10.2 Ground test with engine running

With the engine running at cruising speed check that the aircraft power supply is within the permissible limits.

Perform a communication test to check transmit and receive functionality. When performing a communication test, ensure that the distance to the test station is as wide as possible, at least 100 m.

In transmit operation you should be received well from the test station. In addition you should hear yourself (sidetone) and the cabin noise of the aircraft should be only slightly transmitted. If needed readjust the microphone and the sidetone level in installation setup.

In receive operation you should hear the emitted signal of the test station in a good quality.

Switch on the squelch and check the squelch function. The threshold of the squelch can be set in the pilots menu, refer chapter 3.12.2.

The intercom function should be checked just by talking into the microphone, while engine is running at cruising speed. If necessary, adjust the VOX threshold and the IC volume (both in intercom menu, refer chapter 3.12.1).

2.11 Continued Airworthiness

Maintenance of the VHF-transceiver AR6201 is "on condition" only. No maintenance of this product is required.

It is recommended to check the frequency accuracy of the transmitter after 7 years.

Table of contents

Section	3	OPERATION	Page
3.1		Safety instructions	1
3.2		Controls and Indicators	1
3.2.1		Controls	2
3.2.2		Symbols shown on Display	2
3.3		Start-up	3
3.4		Channel Spacing Mode	4
3.5		Receive and Transmit Operation	5
3.5.1		Receive Operation	5
3.5.2		Transmit Operation	5
3.6		Operation Modes	6
3.6.1		Standard Mode	6
3.6.2		Direct Tune Mode	6
3.6.3		Channel Mode	7
3.6.4		Scan Mode	8
3.7		Squelch	8
3.8		Storage Function	9
3.8.1		Manual Storage Function	9
3.8.2		Automatic storage function	9
3.9		Auxiliary Audio Input	10
3.10		Intercom Operation	10
3.11		VOX & Speaker Operation	11
3.12		Menus	11
3.12.1		Intercom Menu	11
3.12.2		Pilots Menu	12
3.13		Warning and Failure Indications	13



AR6201

Blank

Section 3 OPERATION

3.1 Safety instructions

The following instructions must be followed for safe operation of the VHF transceiver:

Switch OFF the unit before starting or shutting down engines.

A speech test is to be performed before startup and it should be noted that if the speech test is carried out close to the ground station the results may be positive even if the antenna cable is broken or short-circuited. In this case at a distance of 5 to 10 km communication might not be possible.

Use a loud voice for speech communication and hold the microphone close to the lips. Otherwise cabin noise can be intrusive and make understanding difficult.

Use only microphones or headsets which are suitable for use in aircraft. In aircraft made of wood or synthetic materials or in gliders or helicopters, incoming radiation can affect the integrated amplifier of the microphone (feedback). This is noticeable in the ground station by whistling and/or heavy distortion. The described disturbances can occur in different ways on the different transmission frequencies.

For power supply voltages below 10 V the speaker output of the transceiver is automatically switched off, without dedicated notification of the user!

For power supply voltages below 10V pilots have to use the headphone output.

Depending on settings of installation setup "LOW BATT" may be indicated if supply voltage drops below predefined threshold.







If this threshold is adjusted in range 10.2 ... 10.5 V this "LOW BATT" warning may be used as an indication, that pilot should connect his headset, because speaker may be switched off soon.

3.2 Controls and Indicators



Figure 3-1 controls and indicators

3.2.1 Controls



	Symbol	Description	Main Function
1		IC/SQL (Intercom/Squelch)	"Short press" during normal operation toggles squelch ON/OFF state. "Long press" during normal operation activates IC menu.
2		MDE (Mode)	"Short press" during normal operation changes the frequency selection mode. "Long press" during normal operation activates the pilots menu.
3		STO (Store)	"Short press" during normal operation activates storage procedure.
4		↑/SCN (Exchange/SCAN)	"Short press" during standard mode or scan mode exchanges preset frequency and active frequency. "Long press" activates scan mode.
5		Volume Knob	Switches the transceiver ON/OFF and adjusts volume level of received signal.
6		Rotary encoder	Turning rotary encoder changes the settings of several parameters (frequency, IC-volume, VOX ...). Pushing the rotary encoder toggles between the digits and acts as an enter key.

Long press is detected when the user presses and holds the key for at least 2 seconds, otherwise short press is assumed.

When any user action is done (e.g. pressing a key) and the operation performed by this control is not allowed at this time, then for a short period of time whole content of the display is inverted.

Beside the main functions described in the table above, the controls are also used for further functions. This will be described in the dedicated chapter.

3.2.2 Symbols shown on Display

Symbol	Meaning
IC	Intercom operation active (triggered by VOX or external IC key).
	Intercom operation via VOX is disabled.
TX	The transceiver is in transmit operation
SQL	The squelch function is active. Noisy signals will be suppressed.
SCAN	Transceiver operates in scan mode.
	In scan mode an arrow is visible. The arrow points to that frequency (active or preset) from which the audio is derived.

Symbol	Meaning
STO	The transceiver performs a storage operation

3.3 Start-up

CAUTION

Do not switch ON the VHF transceiver when engines are being started or shut down.

Note:

Excessive pulses on the DC bus of the aircraft may cause damage on electrical circuits of any installed instrument.

- a. Switch ON the VHF transceiver by turning the volume knob.
- b. During PBIT the display indicates the message "WAIT", the software version of "Control Head" (CH) and the software version of "Chassis Module" (CM) are indicated.

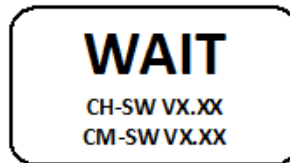

- c. If the PBIT has detected error(s), the display indicates "FAILURE" (for details see chapter 3.13)
- d. If no errors have been detected the transceiver will start in the latest used frequency selection mode before switching off the unit.

3.4 Channel Spacing Mode

The channel spacing in which the transceiver shall work can be toggled by pressing by pressing “STO” and “MDE” keys simultaneously for at least 2 seconds.



8.33 kHz channel spacing (left) / 25 kHz channel spacing (right)

In the 25 kHz Mode only 5 digits will be shown. Only operating frequencies with a distance of 25 kHz will be selected (refer table below). If 8.33 kHz channels are not needed, this mode has the advantage, that tuning is a little bit faster, because the 8.33 kHz frequencies will be skipped.

In the “8.33+25 kHz mixed mode” 6 digits will be shown. The transceiver can be tuned to all frequencies. The channel spacing and operating frequency is derived automatically from the selected and displayed frequency (refer table below).

Operating Frequency (MHz)	Channel Spacing (kHz)	Displayed Frequency in 8.33+25 kHz mixed Mode	Displayed Frequency in 25 kHz Mode
118.0000	25	118.000	118.00
118.0000	8.33	118.005	N/A
118.0083	8.33	118.010	N/A
118.0166	8.33	118.015	N/A
118.0250	25	118.025	118.02
118.0250	8.33	118.030	N/A
118.0333	8.33	118.035	N/A
118.0416	8.33	118.040	N/A
118.0500	25	118.050	118.05
118.0500	8.33	118.055	N/A
118.0583	8.33	118.060	N/A
118.0666	8.33	118.065	N/A
118.0750	25	118.075	118.07
118.0750	8.33	118.080	N/A
118.0833	8.33	118.085	N/A
118.0916	8.33	118.090	N/A
118.1000	25	118.100	118.10

Operating Frequency (MHz)	Channel Spacing (kHz)	Displayed Frequency in 8.33+25 kHz mixed Mode	Displayed Frequency in 25 kHz Mode
118.1000	8.33	118.105	N/A
etc.	etc.	etc.	etc.
136.9750	25	136.975	136.97
136.9750	8.33	136.980	N/A
136.9833	8.33	136.985	N/A
136.9916	8.33	136.990	N/A

3.5 Receive and Transmit Operation

3.5.1 Receive Operation

If PTT key is not pressed, the transceiver stays in receive operation.

In receive operation the headset and (if enabled) the speaker output providing a mixed signal consisting of:

- received signal from antenna on operating frequency
- intercom voice (if intercom is active)
- signal from auxiliary input (if enabled)

The signal from the auxiliary input may automatically be muted under special conditions. For details refer chapter 3.9.

In receive operation user actions are allowed (changing operation modes, channel spacing, menus, storing, external intercom,).

3.5.2 Transmit Operation

If PTT is pressed the transceiver switches into transmit operation. Microphone(s) signals are modulating the transmitter.

Transmit operation is indicated by the "TX" symbol on the left upper corner of the display

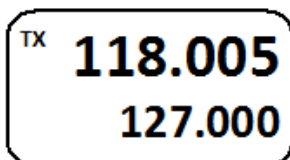

In TX operation, the most user actions (changing operation mode, channel spacing ...) normally allowed in receive operation are blocked. As an exception, the preset frequency in standard mode may still be changed even during transmission.

During TX operation no intercom operation is possible.

During TX operation, the sidetone (demodulated audio of the emitted signal) is available on the headphone output. The speaker is switched off.

Note: Transmit operation will automatically be terminated (return to receive operation) after 120 seconds of continuous transmitting even if PTT is still pressed. In this case "STUCK PTT" will be indicated (refer chapter 3.13). For initiating a new transmission, PTT line needs first to become inactive.

3.6 Operation Modes

The transceiver will always work in one of the four operation modes:

- Standard mode
- Direct tune mode
- Channel mode
- Scan mode

The first three modes (standard mode, direct tune mode, channel mode) are called frequency selection modes and providing different user interface for convenient selection of the operating frequency.

The three frequency selection modes can be toggled by consecutive short pressing of "MDE". They will be toggled in the following order: standard mode, direct tune mode, channel mode, standard mode, etc.

The fourth mode is a special mode called SCAN-Mode for monitoring two frequencies at the same time.

SCAN Mode can be entered and left by long press of "↕/SCN" key.

3.6.1 Standard Mode

Standard mode can be entered by consecutive short pressing of "MDE". Standard mode will be left by selecting another operation mode.

In standard mode the display will indicate the active frequency in the top line and preset frequency in the bottom line.

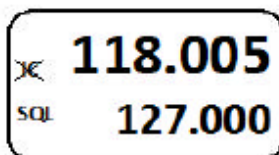

The active frequency can not be edited directly (like in direct tune mode). But the preset frequency can be changed and set by consecutive turning and pushing the "Rotary encoder".

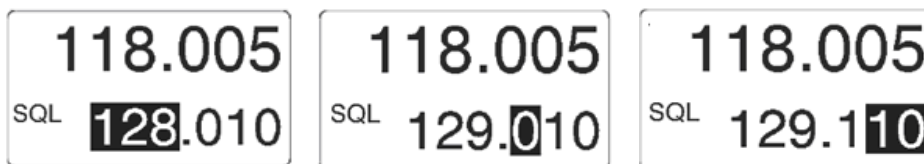

A short press of the "↕/SCN" key exchanges the active and preset frequency. Exchange is disabled while the transceiver is in transmit operation.

3.6.2 Direct Tune Mode

Direct tune mode can be entered by consecutive short pressing of "MDE". Direct tune mode will be left by selecting another operation mode.

In direct tune mode the active frequency is indicated in the top line. The battery voltage is indicated in the bottom line.

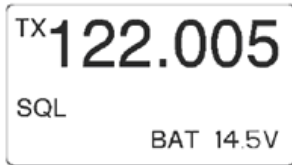

The active frequency can be set directly by pushing and turning the rotary encoder. The changes became active immediately.

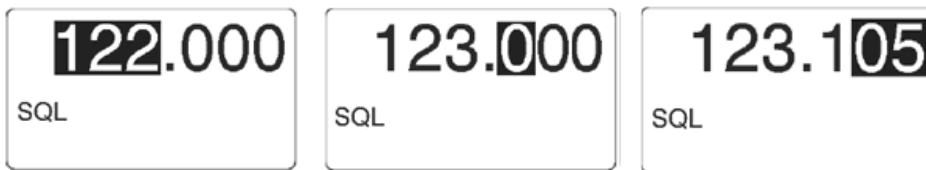

Changing the active frequency is possible only when the transceiver is not transmitting.

3.6.3 Channel Mode

Channel mode can be entered by consecutive short pressing of "MDE". Channel mode will be leaved by selecting another operation mode.

In channel mode the active frequency is indicated in the top line. In the bottom line of the display, the channel number is indicated.

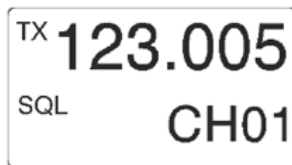

When changed from direct tune mode to channel mode the active frequency stays the same. If the frequency has already an assigned channel number from manual storing, that channel number will be indicated. Otherwise "CH--" will be indicated.

In channel mode only frequencies which have been stored before (automatically or manual) may be selected.

The channel can be selected by pushing and turning the rotary encoder.

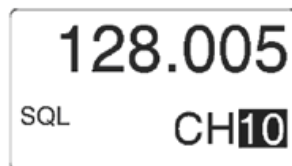

Note: If the device is operating in the 25 kHz mode a selection of an earlier stored 8.33 kHz channel is not possible. For selection of 8.33 kHz channels the device has to be operated in the 8.33+25 kHz mixed mode.

3.6.4 Scan Mode

The Scan mode can be entered from all frequency selection modes by a long press of “↕/SCN” key. The Scan mode can be left by a short press of the “MDE” key. After leaving scan mode, device will enter the standard mode.

Both, preset and active frequency is indicated on the display. The active frequency is indicated in the top line. The preset frequency is indicated in the bottom line. The SCAN sign in the display indicates that scan mode is active.

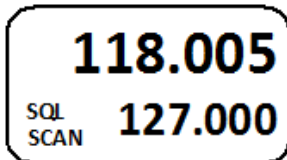

If signal is detected on the active frequency and signal is also detected on the preset frequency, then the preset frequency is inverted and blinking. The active frequency has priority. The arrow sign “▶” near active frequency indicates that audio from active frequency is provided to the audio outputs. Content of display is shown in picture below.

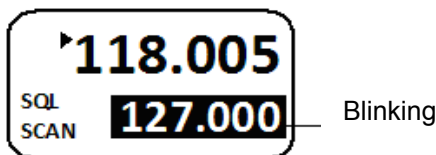

In addition to the blinking of the preset frequency an audio notification (“BEEP”) can be enabled in the installation setup. If enabled a short “BEEP” will be heard once, when a signal on preset frequency is detected, while a signal on active frequency is present and audible.

If a signal is detected on preset frequency, while nothing on the active frequency is received, the transceiver will automatically switch over to the preset frequency. The arrow sign near preset frequency indicates that preset frequency audio is provided to the audio outputs. Content of display is shown in picture below.

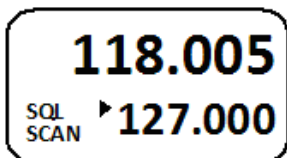

Short press of the “↕/SCN” key exchanges preset frequency and active frequency without leaving scan mode. Exchange is disabled while the transceiver is in transmit operation.

Short press of the encoder push button activates setting of preset frequency (like in standard mode).

Note: Transmission is always done on active frequency even if monitored frequency is currently audible.

3.7 Squelch

In normal operation (no menu opened) the squelch can be toggled between on and off state by short press of the “SQL/IC” key.



Squelch On (left) / Squelch Off (right)

If the squelch function is active (on), noisy signals will be muted. The threshold for the squelch can be adjusted in the pilots menu.

3.8 Storage Function

The transceiver has two kind of storage functions implemented:

- Manual storing of frequencies
- Automatically storing of frequencies

3.8.1 Manual Storage Function

Manual storage of frequencies can be activated by pressing “STO” key in standard mode, direct tune or scan mode.

During storage procedure the display will look similar to the channel mode. But as difference “STO” is displayed on left side of the display. On the top line active frequency is indicated. On the bottom line channel number is indicated. If channel is free, then “FREE” is displayed. If channel contains already an earlier stored frequency “USED” is displayed.



“FREE” and “USED” channel indication.

By entering the storage procedure, the transceiver will first propose the next free channel for storing the active frequency. Beside the proposed channel also every other channel in range 10 to 99 can be selected by turning the rotary knob. For every selected channel “USED” or “FREE” will be indicated respectively.

By pressing the “STO” key once again, the active frequency will be stored on selected channel, independent if the channel is “FREE” or “USED”. Afterwards transceiver will automatically go back to previous mode (standard mode / direct tone mode / scan mode).

If during storage procedure no action occurs during 7 seconds the transceiver returns to the previous mode without storing the frequency.

The stored frequencies can be recalled in channel mode.

3.8.2 Automatic storage function

The transceiver contains an automatic storage function operating in standard mode, direct tune mode and scan-mode.

When changing to a new active frequency, the previous active frequency is stored in memory channel CH01. The frequencies previously located in CH01, CH02 ... CH08 are shifted to memory

channels CH02, CH03, CH09. By this algorithm the last 9 used active frequencies are always stored.

The automatically stored frequencies can be recalled in channel mode.

3.9 Auxiliary Audio Input

The transceiver has an auxiliary audio input. This auxiliary audio input can generally be enabled or disabled in the installation setup.

If enabled the audio signal applied on this input will be fed to the audio output(s) when the transceiver is in receive operation.

If disabled, the audio signals applied on this input will be ignored.

Furthermore in installation setup can also be enabled/disabled a so called "auto aux mute function". If this function is enabled the audio signal from the auxiliary audio input will be muted automatically, when the transceiver detects (based on squelch evaluation) a received antenna signal or user deactivate squelch manually.

If this function is disabled the signal from the auxiliary audio input will be fed to the audio output independent of received signal or squelch status.

The auxiliary audio input signal is (if enabled and not muted) mixed with the received signal from antenna (passing squelch) and the intercom signal (when activated).

3.10 Intercom Operation

The transceiver has an internal built in intercom. When intercom operation is activated, the signals of the microphones are mixed, gained and fitted to the headphone output. In this way aircraft internal communication via headsets is possible. Both pilots will hear each other.

During receive operation the intercom operation may be activated by one of the two possibilities:

- Automatically via VOX (threshold adjustable in the intercom menu).
- Externally via intercom switch (pin P1-7).

If intercom operation is activate the "IC" sign will be displayed.

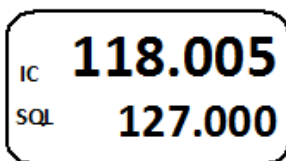

Intercom operation is not possible in transmit operation.

Intercom activation via VOX is not possible if:

- Speaker is enabled (see next chapter).
- User switched the VOX off (refer intercom menu)

In both cases the display will show the ~~IC~~ sign to indicate that activation via VOX is not possible.

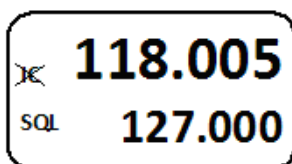

Intercom operation can be activated by external intercom switch independent of VOX or speaker status (enabled/disabled). The external intercom switch has priority. Speaker output is switched off during intercom operation.

3.11 VOX & Speaker Operation

Depending on wiring and installation setup, the speaker may be enabled always or the speaker is enabled/disabled by an external switch. (For details refer chapter 2.4.2, /MIKE_SW).

When speaker operation is enabled, the VOX is always forced off and intercom via VOX is not possible (to avoid oscillation of VOX due to feedback).

Speaker output will be switched off even if speaker is enabled in following cases:

- Transceiver is in transmit operation.
- Intercom was activated by external intercom switch.
- Power supply is below 10 Volt.

3.12 Menus

During normal operation in one of the four operation modes above the following menus can be entered:

- IC menu for adjustment of intercom volume and VOX threshold.
- Pilots menu for adjustment of panel brightness and squelch threshold.

3.12.1 Intercom Menu

The intercom menu can be entered by long press of "IC/SQL" key.

The intercom menu can be left by waiting 5 seconds doing no action or by short press of "MDE".

The intercom menu consists of two pages:

- Intercom volume (first page).
- Intercom VOX (second page).

When in intercom menu, toggling between intercom volume and intercom VOX can be done by short press of the "IC/SQL" key.

Intercom Volume is displayed as first page (after entering the intercom menu). The active frequency is indicated in the top line of the display. On the bottom line is indicated "IC Volume" with bar graph and value.

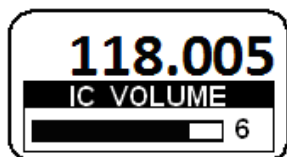

By turning the rotary encoder the intercom volume can be changed.

0 means minimum volume.

46 means maximum volume.

By a short press of the "IC/SQL" key (or pushing the rotary push button) the next page **Intercom VOX** is displayed. The active frequency is indicated in the top line of the display. On the bottom line is indicated "IC VOX" with bar graph and value.

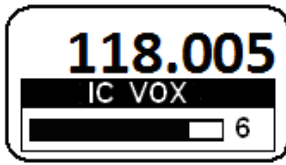

By turning the rotary encoder the intercom VOX threshold can be changed.
 -30 means that VOX is very sensitive. A very silent signal already activates the intercom operation.
 +10 means that VOX is quite insensitive. Only a loud signal activates the intercom operation.

Note: For a VOX threshold setting of -15 a good VOX behavior should be achieved in most aircrafts. This requires that the mike sensitivity had been correct adjusted (installation setup). If the mike sensitivity is not correct adjusted VOX may work not satisfying.

An adjustment of the VOX threshold level is not possible if the VOX is forced off (due to enabled speaker).

VOX can be switched off by turning the VOX threshold level “above” +10. In this case the display will show:

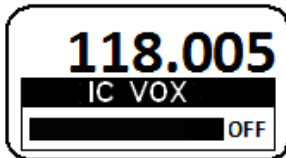

When VOX is switched off, the intercom operation may still be activated by the external intercom switch.

3.12.2 Pilots Menu

The pilots menu can be entered by long press of “MDE” key.
 The pilots menu can be left by waiting 5 seconds doing no action or by short press of “MDE”

The pilots menu consists of two pages:

- Brightness (first page).
- Squelch (second page).

When in pilot menu, toggling between brightness and squelch can be done by short press of the push-button of rotary encoder.

Brightness is displayed as first page (after entering pilot menu). The active frequency is indicated in the top line of the display. The brightness value in the bottom line of the display.

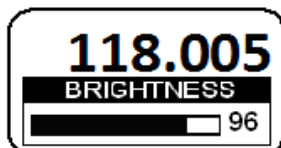

By turning the rotary encoder the panel brightness (illumination for push-buttons and LCD) can be changed from 0 to 100.

0 means that the illumination is off.
 100 means that the illumination is maximum.

Note: This page is not available if in the installation setup the dimming input is set to 14V or 28V.

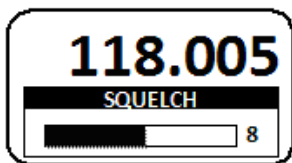

By a short press of the push button of the rotary encoder the next page **Squelch** is displayed. The active frequency is indicated in the top line of the display. On the bottom line is indicated "SQUELCH" with bar graph and value.

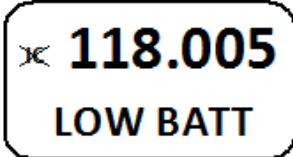
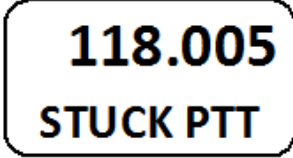
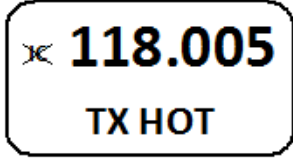

By turning the rotary encoder the squelch threshold can be changed from 6 to 26. 6 means that also very weak and noisy signals will be audible. Squelch opens around -105 dBm. 26 means that only quite strong signals with low noise content will be audible. Squelch opens around -87 dBm.

3.13 Warning and Failure Indications

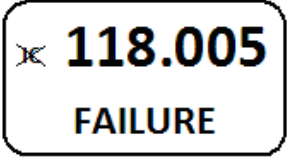
Display Contents	Description
 Appearance about every 5 seconds.	"LOW BATT" is indicated if the supply voltage of the transceiver is below the threshold defined in the installation setup. Transceiver is still operable. Depending on supply voltage transceiver may have a reduced performance. Below 10 V speaker output is switched off! <u>Possible reasons for indication:</u> <ul style="list-style-type: none"> - Problems with capacity of accumulator (gliders). - Power interrupts. - General problem with power supply. - Wrong (too high) adjusted threshold in installation setup.
 Appearance about every 5 seconds.	"STUCK PTT" is indicated after 120 seconds of continues transmitting. The transceiver goes back to receive mode even if the PTT line is still active (GND). For initiating a new transmission, the PTT line needs first to become inactive (open). <u>Possible reasons for indication:</u> <ul style="list-style-type: none"> - Transmitting more than 120 seconds. - Stuck of PTT-key. - PTT line permanent grounded (short circuit in installation).
 Appearance about every 5 seconds.	"TX HOT" is indicated if the internal device temperature exceeds +75°C. Transceiver is still operable. Performance of transmitter is reduced. <u>Possible reasons for indication:</u> <ul style="list-style-type: none"> - Very hot environmental temperature, long transmissions times and insufficient airflow conditions.

Display Contents	Description
 <p>Appearance about every 5 seconds.</p>	<p>The transceiver has detected an internal failure during normal operation. Depending on failure reason, the device may be still operable with degraded performance or not operable at all.</p> <p><u>Possible reasons for indication:</u></p> <ul style="list-style-type: none"> - Out of specified environmental conditions - HW or SW failure inside the transceiver. <p>Contact maintenance shop for assistance.</p>
	<p>The transceiver has detected an internal failure during start up. Depending on failure reason, the device may be still operable with degraded performance or not operable at all.</p> <p><u>Possible reasons for indication:</u></p> <ul style="list-style-type: none"> - Out of specified environmental conditions - HW or SW failure inside the transceiver. <p>Contact maintenance shop for assistance.</p>